



# Elmdale

Woodburning Stove • Model FB5BK

To be retained by the user for future reference

Thank you for purchasing an ACR Heat Products stove



Serial Number:

Document FB5BK 0101 • Version 2 Date 07/06/16

T  
E  
C  
H  
N  
I  
C  
A  
L  
M  
A  
N  
U  
A  
L

# Important!

To ensure that you gain the most from your purchase, please take a few minutes to read through this manual before lighting the appliance for the first time.

Before installation, please ensure that the correct model has been supplied.

Please make a note of the serial number of your appliance in the space provided on the front cover of this manual as this will be requested if you require technical assistance in the future.

Please also ensure that the commissioning checklist at the rear of the manual is completed in full.

Since April 2002 only registered competent installers can install solid fuel appliances. Installations carried out by non-registered installers must be inspected by local authority building control.

For more information please contact hetas at: [www.hetas.co.uk](http://www.hetas.co.uk) or telephone: 0845 6345626

- The installation of this appliance must comply with current Building Regulations and local regulations, including those referring to national and European standards.
- Do not operate this appliance if it becomes damaged.
- Improper use, maintenance or fitting parts other than those approved by the manufacturer could lead to the appliance becoming damaged or unsafe which in turn could lead to personal injury or damage to the property and will void the warranty.
- The appliance must not be modified in anyway unless authorised by ACR Heat Products Ltd.
- The appliance should be inspected regularly to ensure the airways are clean and free from obstruction and the chimney swept at least once a year.
- The external surfaces of this appliance will be very hot to the touch when in operation and due care will need to be taken when operating the appliance to ensure safety. A fire guard should be fitted if it is likely that the elderly, infirm or children may come into contact with the appliance.
- This appliance must not be used as an incinerator.
- This appliance has been designed for intermittent operation.

## Tenbury Specifications

Nominal heat output	9 kW - Wood
Chimney draft required	12Pa
Height	Up to 1590 mm
Width	800 mm
Depth	475 mm
Weight	115 kg
Air Requirement	220mm <sup>2</sup> ***
Flue Mass Gas Flow	8.7g/s - Wood
CO @ 13% O <sup>2</sup>	0.06 Wood Vol%
Mean Flue Gas Temperature	263°C - Wood
Efficiency	79.3% - Wood
Log Length	Up To 450 mm
Hearth Temperature	157°C

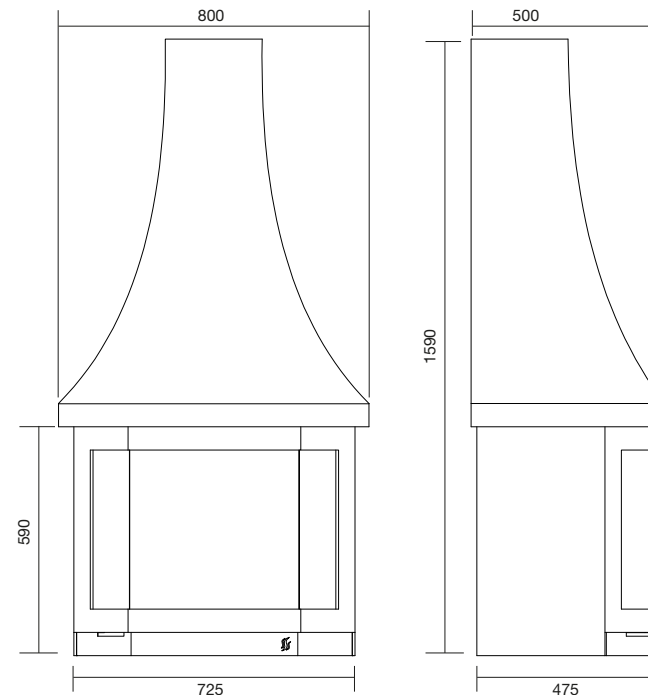

\*\*\* Please note that Building Regulations Document J advises that additional permanent air supply is required for appliances with an output of above 5Kw.

With modern properties additional air may be required as Document J suggests that adequate air would be a benefit.

- If design air permeability  $\geq 5.0\text{m}^3/\text{(h.m}^2\text{)}$  then 550mm<sup>2</sup>/kW of appliance rated output above 5kW
- Or
- If design air permeability  $\leq 5.0\text{m}^3/\text{(h.m}^2\text{)}$  then 550mm<sup>2</sup>/kW of appliance rated output
- If in doubt, please consult your registered installer for advice.

**DO NOT INSTALL IN A ROOM CONTAINING AN EXTRACTOR FAN UNLESS THE APPLIANCE HAS BEEN CORRECTLY TESTED IN ACCORDANCE WITH BUILDING REGS DOC J**

## The Clean Air Act 1993 and Smoke Control Areas

Under the Clean Air Act local authorities may declare the whole or part of the district of the authority to be a smoke control area. It is an offence to emit smoke from a chimney of a building, from a furnace or from any fixed boiler if located in a designated smoke control area. It is also an offence to acquire an "unauthorised fuel" for use within a smoke control area unless it is used in an "exempt" appliance ("exempted" from the controls which generally apply in the smoke control area).

The Secretary of State for Environment, Food and Rural Affairs has powers under the Act to authorise smokeless fuels or exempt appliances for use in smoke control areas in England. In Scotland and Wales this power rests with Ministers in the devolved administrations for those countries. Separate legislation, the Clean Air (Northern Ireland) Order 1981, applies in Northern Ireland. Therefore it is a

requirement that fuels burnt or obtained for use in smoke control areas have been "authorised" in Regulations and that appliances used to burn solid fuel in those areas (other than "authorised" fuels) have been exempted by an Order made and signed by the Secretary of State or Minister in the devolved administrations.

- **The Elmdale (FB5BK) has been recommended as suitable for use in smoke control areas when burning wood.**



Further information on the requirements of the Clean Air Act can be found here: <http://smokecontrol.defra.gov.uk>

Your local authority is responsible for implementing the Clean Air Act 1993 including designation and supervision of smoke control areas and you can contact them for details of Clean Air Act requirements.

## CO Alarms

It is required by building regulations that whenever a new or replacement wood/solid fuel or biomass appliance is installed in a dwelling a carbon monoxide alarm to BS EN 50292:2002 must be fitted in the same room as the appliance.

The alarm should be installed according to the alarm manufacturers instructions and should not be considered a substitute for the appliance being installed incorrectly or regular maintenance of the appliance or flue system.

## Installation Instructions

### Important information

Before installation and/or use of this appliance please read these instructions carefully to ensure that all requirements are fully understood.

This appliance must be installed by a registered engineer, or approved by building control, failure to do so may endanger life and property.

All the below instructions should work in conjunction with building regulations document J, if there is a variation the most stringent requirement should be adhered to.

### Asbestos

This appliance contains no asbestos, if there is the possibility of disturbing any asbestos in the installation of this appliance then specialist advice must be sought and appropriate precautions taken.

### Metal Parts

This appliance may contain sharp metal edges, take care when installing or servicing this appliance to avoid personal injury. Please use appropriate personal protective equipment at all times.

Each installation is unique to the property, the information contained in this manual may not give exact installation requirements for your installation.

The installation must comply with Building Regulations, European Standards and Local authority bylaws.

### Fire Cement

Some types of fire cement are caustic and should not be allowed to come into contact with the skin. In case of contact wash immediately with plenty of water.



## Location of the unit

The appliance must stand on a non-combustible constructional hearth which is at least 125mm thick with the minimum dimensions as shown in the above diagram (please see Building regs. Document J For further information).

If the appliance is to be fitted in a raised application, due consideration should be given to extending the depth of the superimposed hearth to safely contain any falling embers or logs.

The hearth and building construction must be of a suitable material to comply with current building and local authority regulations, the fabrication of the construction must have a suitable load bearing capacity for the appliance and hearth.

If in any doubt, please consult a competent person for advice before proceeding.

The construction of fireplace recess should be of a suitable non-combustible material such as brick or concrete

blockwork, and have a minimum thickness of 200mm to the sides and rear of the appliance unless, it is a back to back recess within the same property.

Please refer to building regs document J for more information.

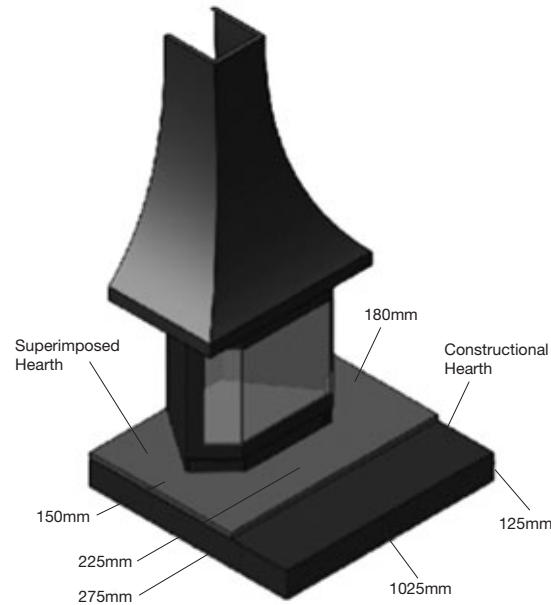

## Clearances

### Clearances to non-combustible materials

There is a recommended minimum clearance of 50mm at each side of the appliance. A clearance of 150mm is required at the back of stove (if the rear wall has a thickness of 200mm or more this measurement can be reduced to 50mm).

### Clearances to combustible materials

There must be a minimum clearance of

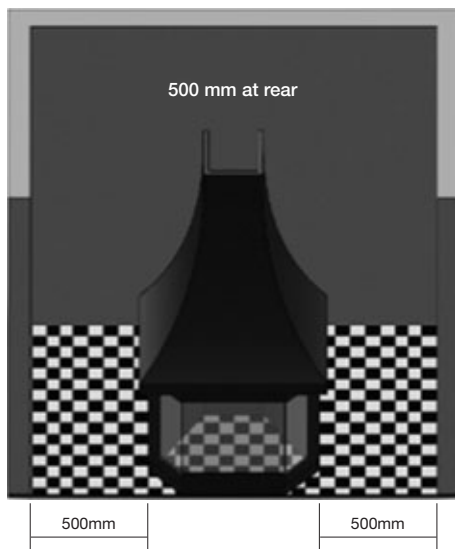

500mm at each side and 500mm at the rear of the appliance from any combustible materials. If using single wall flue pipe, there must be a clearance of at least 3 times the diameter of the flue pipe (e.g. 125mm diameter pipe = 375mm minimum clearance) from any combustible materials e.g. wooden beam.

Please refer to building regs document J for more information.

Curtains and soft furnishings should be a minimum of 1m away from the appliance.

We do not recommend that plasma televisions and expensive artwork are hung over the fireplace.

## Flue Requirements

The flue must comply with current Building Regulations Document J.

The construction of masonry, flue block, insulated flue systems and flexible flue liners must comply with the manufacturers instructions at all times.

### The flue must be:

- ✓ A minimum 150mm flue diameter is required
- ✓ In sound condition and provide sufficient draft (minimum 12pa)
- ✓ Suitable for use with solid fuel burning appliances
- ✓ Be able to clean the entire length of the flue system without removal of the appliance

- ✓ Free from deposits
- ✓ Well insulated
- ✓ At least 3.5m in height from hearth level to termination, with no more than 4 x 45° bends in any one flue system and have a maximum horizontal length of no more than 20% of the overall vertical height
- ✓ The termination should be sited as to avoid a negative pressure zone

### The flue must not be:

- ✗ Shared with other appliances
- ✗ Weight bearing on the appliance
- ✗ A smaller diameter than the appliance flue collar size (150mm)

## Installation of the unit

### This appliance cannot be installed with a rear flue option

### Smoke Exempt stop

Prior to installing the appliance the smoke exempt stop must be installed if the appliance is being used for burning wood logs in a smoke exempt area.

Install the smoke exempt stop prior to installing the Elmdale canopy.

To install the smoke exempt stop,

Remove the left hand side nut from the secondary (top) air slider located on the top of the appliance, place the smoke exempt stop over the threaded bolt with the tab facing downwards into the groove of the air slider, Re-tighten the nut and check the free movement of the air slider.

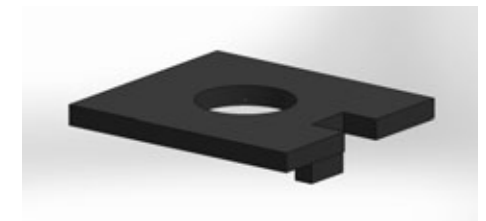

## Installing the appliance

- 1 Install the top canopy support above the door on the internal face of the appliance using the pre-drilled holes and bolts supplied.

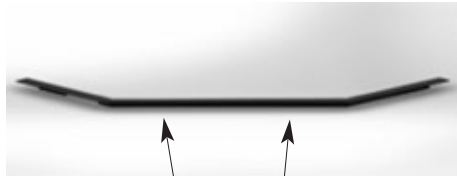

Insert bolts here

- 2 Install the two top/side support brackets, remove the nut on the upper left and right side on the casting and insert the support bracket onto the bolt, retighten nut



- 3 Install the two lower/side support brackets, remove the nut on the upper left and right side on the casting and insert the support bracket onto the bolt, retighten nut

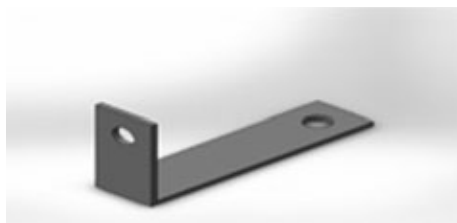

- 4 Affix side/rear cover using the 4 bolts provided to the top and lower support brackets.

- 5 Install the unit into the desired position and make the flue connection using the 150mm flue adaptor supplied

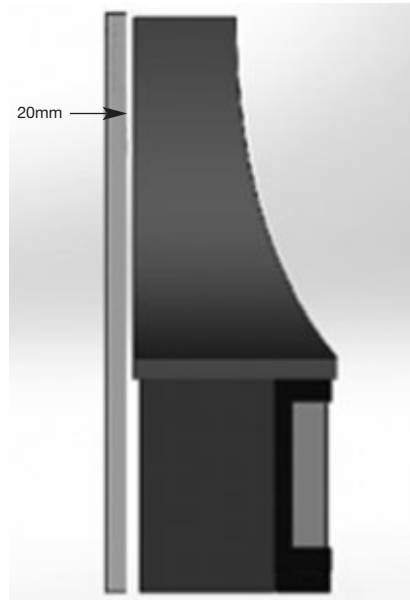

- 6 Install the canopy onto the top support bracket and position the canopy ensuring that there is a minimum 20mm air gap between the rear of the canopy and the non-combustible wall, once in position drill and self-tap the underside of the canopy through the top support bracket

## Operating your stove

Please note that during the first firing, we recommend a small fire is lit and that you slowly increase the temperature to enable the various parts to expand normally.

- You may also experience fumes and a haze being given off by the stove during the first firing and possibly for the next couple of firings as the paint cures. This is normal, but please ensure that the room is well ventilated during this period.
- The appliance should not be operated in mild weather with smokeless fuel. Under certain weather circumstances e.g. fog the chimney will not draw sufficiently and could cause asphyxiation. Either await better weather conditions or burn wood only.
- In the rare event of a malfunction due to overheating or a chimney fire, the air slides should be shut down completely and the fuel allowed to burn out. In the event of a chimney fire, once the air slides have been closed

### Recommended Fuels

- ✓ **Wood:** hardwood such as ash, oak and beech which have been cut for at least 2

years and stored under shelter. The logs should have a maximum moisture content of 20%. Maximum log length 250mm, maximum width 125mm.

### Prohibited Fuels

- ✗ **Green wood:** i.e wood which is less than 2 years old with a moisture content of above 20%
- ✗ **Recovered wood:** i.e pallets, railway sleepers etc. These will have been chemically treated and will pollute the atmosphere and possibly overheat the appliance.
- ✗ **Housecoal or Bituminous coal:** these fuels will soot up the airways of the stove and possibly overheat the appliance.
- ✗ **Petroleum Based Coke:** over 20% content - this will overheat the appliance and possibly damage the unit.
- ✗ **Liquid fuels.**
- ✗ **Paraffin fire lighter blocks..**

Always check with your dealer or directly with the manufacturer as using the incorrect fuel may invalidate your guarantee and damage your appliance.

### Using your appliance for the first time

- To allow the appliance to bed in, and fixing glues and paint to fully cure, only fire the appliance using kindling and just get hot for at least three fires.
- Before lighting the next small fire

please allow the appliance to return back to room temperature.

- During these first small fires you may experience a haze and unpleasant smell as the paint cures, do not touch the paint and keep the room well ventilated.



## Instructions for use

- Open the secondary air slider, to the top left hand side of the door, and open the primary air slider, to the bottom left hand side of the door, fully by sliding them fully right in line with the body of the stove.
- Lay firelighters or rolled up newspapers on the grate and add a small amount of kindling wood to the top. Place 1 or 2 small logs on the top.
- Light the newspaper or firelighters using a long taper and push the door closed but do not engage the locking handle fully.
- When the fire is burning fiercely, after a couple of minutes add more logs and close the door.
- When the fire has become established, close the primary air, to the bottom left hand side of the door, by pushing the lever left in line with the stove.
- The burning rate can be altered by moving the secondary air slider, to the top left hand side of the door – push the lever towards the left to close down and pull to the right to increase the burn rate.
- Care should be taken to ensure that the logs are not placed in such a way that may allow the fuel to fall out of the burning chamber.

## Re-fueling

When refueling the stove always refuel onto a bed of hot embers, fully open the secondary and primary air controls until the new fuel is well alight, before adjusting the air controls for the desired setting.

If there is insufficient burning material in the firebed to light a new fuel charge, excessive smoke emission can occur.

Refueling must be carried out onto a sufficient quantity of glowing embers and ash that the new fuel charge will ignite in a reasonable period. If there are too few embers in the fire bed, add suitable kindling to prevent excessive smoke.

## Fuel overloading

Never overload the stove – it will work very well with three medium sized logs. The amount of fuel specified in this manual should not be exceeded, overloading can cause excess smoke.

## Operation with door left open

Operation with the door open can cause excess smoke and overfiring of the appliance. The appliance must not be operated with the appliance door left open except as directed in the instructions.

**Never leave the stove unattended until the new fuel is well alight.**

Persistent fume emission is dangerous and must be investigated.

If fume emission persists, open doors and windows to ventilate the room and let the fire die out. Have the chimney inspected for blockages and clean if required. Do not relight the fire until the cause has been found. We recommend that you seek professional advice.

This appliance has been designed to be burned with the door closed at all times other than when refueling.

It should not be operated as an open fire.

Typical refueling intervals for wood is 1 hour and smokeless fuel is 2 hours.

## Maintenance

**We recommend that the appliance is serviced annually by a competent engineer to ensure it's continued safe operation.**

### Daily Maintenance

- The ash pit should be checked and emptied regularly.

### Periodic Maintenance

- The chimney should be swept at least once a year together with the flue pipe connection. Care should be taken to ensure that there is not a build up of soot on the baffle and in the airways of the appliance.
- If the appliance has not been operated for long periods, the flue should be

inspected and swept before use to ensure there are no blockages within the flue.

- Check the rope door seals are intact and are not worn. These should be replaced on an annual basis to ensure the correct operation of this appliance.
- The glass can be cleaned using a soft damp cloth and window cleaner or ACR stove glass cleaner (available from your local stockist)

**Use only replacement parts recommended by the manufacturer.**

## Commissioning Check List

**Please tick boxes when each procedure is completed**

- Ensure the serial number has been recorded on the front of this manual for any future use
- Ensure the door seals are in good condition and that the glass is secured correctly in the door (do not over tighten the glass as this will prohibit its expansion and could cause the glass to crack)
- Ensure that all internal components are fitted correctly (these may have shifted in transit)
- Ensure that the appliance operates correctly during the first firing
- Ensure the customer is aware that fumes may be given off during the first firings as the paint cures
- Advise the customer on the safe operation of the appliance
- Leave the instruction manuals, operating tool and glove for the customer's use.
- Record the flue draught reading of the appliance

# Parts Information

Diagram No.	Part No.	Description
1	03.09229.105	Bottom Plate
2	03.55442.000	Ring
3	03.38005.000	Draft Control Under
4	03.13630.000	Bush Ø12xø6x4.5
5	03.18701.000	Washer 6x18
6	03.19305.000	Hexagon Hexagon Head Screw M6x20
7	03.37678.100	Air Tunnel
8	03.19302.000	Hexagon Hexagon Head Screw M6x10
9	03.79268.102	Side Left
10	03.79269.102	Side Right
11	03.22202.041	Hexagon Flange Bolt M8x30 Black
12	03.22203.041	Hexagon Blind Rivet Nut M8
13	03.56019.105	Smoke Dome
14	03.24468.202	Front
15	03.18615.000	Screw M8x35
16	03.37501.002	Air Deflector
17	03.38006.000	Draft Control Upper
18	03.18710.000	Washer 8x25
19	03.19401.000	Hexagon Nut M8
20	03.13657.041	Bush
21	03.13656.000	Bush
22	03.19306.041	Hexagon Hexagon Head Screw M6x25 Black
23	03.15968.405	Door
24	04.26408.000	Glass Fiber Rope Ø8mm
25	03.17507.000	Hinge Pin 6x60
26	03.21739.041	Set Screw M5x5 Black
27	02.65472.000	Rod Handle
31	03.31443.000	Clamping Plate Hinge Pin
32	03.16304.041	Screw M6x12
33	03.33064.105	Knob Latch
34	03.18601.041	Screw M6x12
35	02.26155.121	Glass Retainer
36	03.16505.000	Washer 12x24
37	03.19405.041	Hexagon Nut M5 Black
38	03.76179.000	Baffle Plate
39	03.77418.102	Log Retainer
40	04.26419.000	Glass Fiber Rope Ø6mm Self Adhesive
41	03.26364.000	Glass
42	03.77516.100	Vermiculite Baffle Plate
43	03.13642.100	Magnet 30x10x3
44	03.66186.021	Protection Profile Right
45	03.66185.021	Protection Profile Left
46	03.19507.000	Stud M8x20
49	03.00387.021	Flue Collar
50	02.59203.000	Scraper
53	03.44626.000	Lower Panel
54	03.02495.005	Back Plate
55	03.19318.000	Hexagon Hexagon Head Screw M8x75

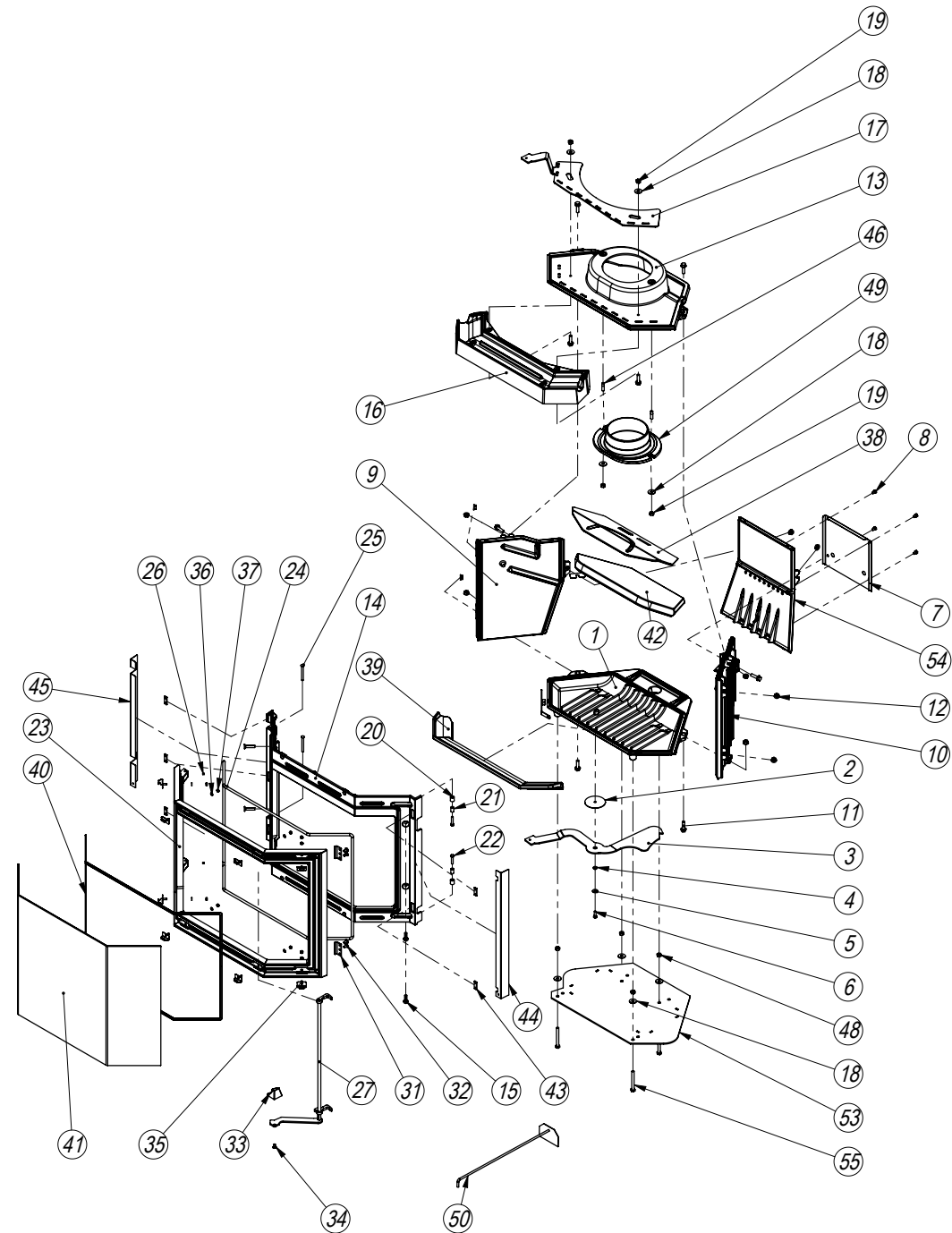

## Warranty Information

The specifications within this document are provided for information purposes only and are under no circumstances binding.

With the aim of constantly improving our products, all modifications considered necessary may be made without notice.

This manual is correct at time of printing.

**Our appliances are guaranteed against faults and hidden defects subject to the following conditions:**

- The appliance must have been installed by a registered competent installer (e.g. HETAS) or inspected by local authority Building Control.
- The appliance must be installed and operated in accordance with our instruction manual.

- The guarantee is for a period of 10 years on the appliance body from the date of purchase.

The following components are considered as consumables and are excluded from the guarantee:

- Grates
- Rope seals
- Ashpan
- Internal vermiculite panels
- Glass
- Baffle plates
- log guard

Your statutory rights are not affected by this warranty.



**In the unlikely event of a warranty claim, please return the claim form to:**

ACR Heat Products Limited, Unit 1, Weston Works,  
Weston Lane, Tyseley, Birmingham, B11 3RP, England.

- Tel: 0121 706 8266
- Fax: 0121 706 9182
- E-mail: [enquiries@acrheatproducts.co.uk](mailto:enquiries@acrheatproducts.co.uk)
- [www.acrheatproducts.co.uk](http://www.acrheatproducts.co.uk)

## Warranty Claim Form

Customer Name:

Customer Address:

Postcode:

Daytime Tel:  Mobile Tel:

Model Name:  Model Number:

Serial Number:  Date of purchase:

Date of installation:

Installer's Name and address:

Installer's Registration Number:

HETAS / Building Control Certificate Number:   
(if not installed by a registered competent installer)

Dealer Name and address:



# Troubleshooting

Problem	Probable Cause	Action Recommend
<b>Fire difficult to start / goes out</b>	• Green wood / wet wood	Use hardwood logs with a maximum moisture content of 20%
	• Logs are too large	Use kindling and small logs to start the fire and once established use split logs
	• Not enough primary air	Open air control
	• Insufficient draft	Check the flue is not obstructed
<b>Fire burns too quickly</b>	• Too much draft	Reduce the air control
	• Excessive draft	Install a draft stabiliser
<b>Smokes on initial lighting</b>	• Flue is cold	Burn paper and kindling to increase heat in flue
<b>Smokes while burning</b>	• Insufficient draught	Check the flue is not obstructed
<b>Low heat output</b>	• Poor quality wood	Use seasoned Hardwood (this has a Higher calorific value)



ACR Heat Products Limited, Unit 1, Weston Works,  
Weston Lane, Tyseley Birmingham B11 3RP, England.

- Tel: 0121 706 8266
- E-mail: [enquiries@acrheatproducts.co.uk](mailto:enquiries@acrheatproducts.co.uk)

- Fax: 0121 706 9182
- [www.acrheatproducts.co.uk](http://www.acrheatproducts.co.uk)